



User manual for Electric Smokers with smoke generator for domestic use

MANUAL FOR SMOKERS: BBDST-70, BBDST-150, UWDT-70, UWDT-150

The sections included in this manual

- I. Safety requirements and precautions
- II. Terms of use
- III. Technical parameters
- IV. Composition of the set
- V. Construction and description of the operation
- VI. Operation of the electronic control panel
- VII. Assembly and installation
- VIII. First start
- IX. Maintenance
- X. Regulations
- XI. Vorschriften

Manufacturer:

ZUT BORNIAK Dawid Szurlej
ul. Aleja Niepodległości 41,
78-449 Borne Sulinowo

NIP: PL 8992343025
Tel: (+48) 94 373 00 02
E-mail: info@borniak.pl
Web: www.borniak.pl



Before using the device,
read the instructions.



I. Safety requirements and precautions

NOTE - ELECTRICITY

- Device should be powered from the mains with an alternating current of 220 - 240V.
- Internal installation must have a 16A fuse.
- Device must be unconditionally connected to the socket outlet with earthing contact.
- If the power cord or plug is damaged, to avoid danger, it should be replaced at the manufacturer, or by a specialised repair shop, or by a qualified electrician.
- Before starting cleaning the device, disconnect the power supply.
- Smoke generator can only be connected to the power supply after it has been installed in the device adapted to its assembly.
- If you use an electric extension cord, its current load should be at least as much as the rated load of the device.
- If you use an electric extension cord, make sure it has an efficient earthing contact (ground).
- Lay the power cords in such a way that they are not crushed, prevent it against pulling or stumbling over by children.
- If you use electric extension cords, they must be adapted for outdoor use and should be labelled "for outdoor use".
- The socket outlet from which the device is to be powered should be protected with an earth leakage circuit breaker with $I_r < \text{or} = 30 \text{ mA}$.

NOTE - LOCATION

- Power cords of the device should be arranged in such a way that they are not in contact with hot parts of the housing.
- The smoker is intended for outdoor use but it must not be exposed to atmospheric precipitation and strong gusts of wind. The optimal solution is to work in roofed, sheltered and, at the same time, ventilated places.
- Do not use the device in closed rooms, in case of use under a roof ensure sufficient ventilation.
- Do not use the device near gasoline or other flammable liquids, gases or places where flammable vapours may be present.
- Do not use the device near flammable objects.
- Do not use the device when it comes in contact with parts, objects made of materials not resistant to high temperature.
- It is recommended to put an extinguisher near the device. Information on the proper size and type of the extinguisher can be obtained from the local authorities.
- Do not connect the device until it has been fully assembled.
- Do not move the device before removing all moving objects inside the smoker and the smoke generator.
- Do not connect the device to the chimney, ventilation grille or other wires that may cause forced air draft.
- Do not place the device next to the wall, keep a minimum distance of 5 cm.

⚠ ATTENTION - TEMPERATURE

- When using parts, they can get very hot. There is a risk of burns when carelessly handled.
- Do not touch hot surfaces, use suitable gloves.
- Children and pets must not approach the device unattended, there may be a risk of burns.
- Before cleaning the device, allow the device to cool down.
- Do not use gasoline, kerosene, spirits or other flammable substances to clean the device.

ℹ PRECAUTIONS

- Do not allow the device to be flooded with water (e.g. during cleaning or by leaving the device uncovered outside during atmospheric precipitation).
- The smoke generator can only work with smoking unit recommended by the manufacturer.
- Using accessories not recommended by the manufacturer may result in injury or damage to the device for which the manufacturer is not responsible.
- Be careful with sharp edges when assembling and disassembling the device.
- Do not use the device contrary to its intended use.
- The device is intended for home use.
- Do not leave the device switched on after finishing smoking.
- The device should be inaccessible to animals.
- Do not allow children to use the device without strict surveillance and care.
- This device is not intended for use by persons (including children) with limited physical, sensory, or mental capabilities, or insufficient knowledge and experience.
- Children should not have access to the device.
- Do not use the device contrary to its intended use.
- The devices require strict surveillance during use.



*Please read the above notes and tips,
it will ensure safe and comfortable work
with your new device.*

II. Terms of use

- Do not use the smoker as an oven (do not use high temperatures for a long time).
- Do not leave the device unattended.
- Do not exceed the maximum temperature.
- Do not use damaged electric cables.
- Do not use the smoker during rain, strong wind or storm.
- Do not use the smoker near flammable substances.
- It is not recommended to wear loose clothing or untied hair.
- Do not move the device during operation.
- Do not use in closed rooms, only for outdoor use.
- Do not put the device in a place accessible to children or animals.
- Do not touch hot components to avoid burns, it is recommended to use gloves protecting against high temperature.
- Do not use the packaging to cover the device.
- It is mandatory to connect the device to a grounded electrical outlet, an extension cord.
- Protect against rain and water access.
- After each use, switch off the device from mains / power supply if it is not used.
- Thoroughly clean the smoker after each use.
- Do not cover or put anything on it when the device is in use.
- Empty the bowl for ash and fat every 2 - 3 hours and fill it with fresh water.
- The socket outlet from which the device is to be powered should be protected with an earth leakage circuit breaker with $I_r < \text{or} = 30 \text{ mA}$
- Do not place the device next to the wall, keep a minimum distance of 5 cm.
- When smoking fatty foods (and when there is a risk of fat melting), protect the drip tray to prevent fat from dripping onto it - it is best to use an additional metal tray where fat can collect. The drip pan should be inserted at least on the second shelf, counting from the bottom.



*If you have questions or concerns about using
Borniak products, we encourage you to contact us.*

You can find contact information on the website www.borniak.com

III. Technical parameters

TECHNICAL PARAMETERS OF THE SMOKER

Model/Typ	UWDT-70	BBDST-70	UWDT-150	BBDST-150	GD-01, GDS-01
Rated voltage	230V	230V	230V	230V	230V
Power	615W	1115W	1515W	2015W	115W
Power of the chamber burner	500W	1000W	1400W	1900W	110W
Fuse	8A (1,25A)	10A (1,25A)	8A (1,25A)	10A (1,25A)	1,25 A
Chamber capacity	70L	70L	150L	150L	2L
Maximum temperature	120°C	150°C	120°C	150°C	-
The Degree of the housing tightness	IP20				

OVERALL DIMENSIONS (EXTERNAL)

Width [mm]	630	720	360
Depth [mm]	400	520	180
Height [mm]	1040	1220	250

DIMENSIONS OF THE CHAMBER (INTERNAL)

Width [mm]	400	490	-
Depth [mm]	300	420	-
Height [mm]	580	755	-

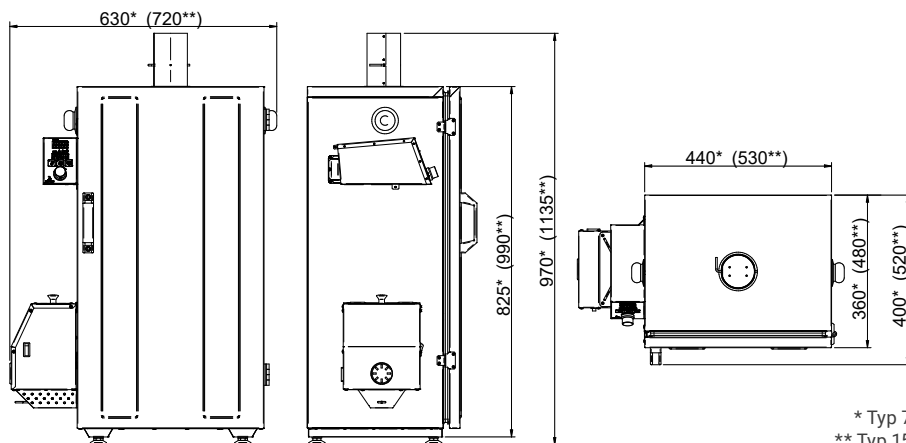

* Typ 70
** Typ 150

IV. Composition of the set

MODEL: UWDT/BBDST:

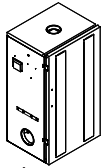

Smoker chamber

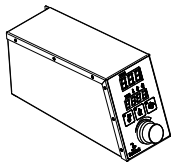

Control panel

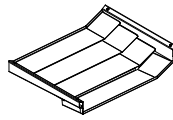

Drip tray

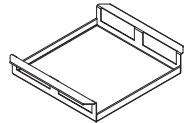

Condenser

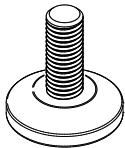

Adjustable legs
4 pcs.

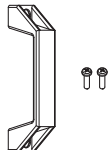

Door handle
+ screws 2 pcs.



Carrying handles
2 pcs.

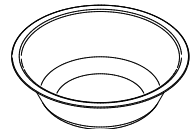

Water bowl
2 pcs.

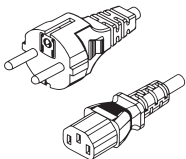

Power cord
EU* - C13

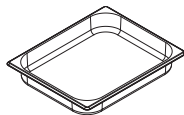

GN 1/2 tray
(only BBQ version)

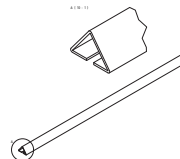

Crossbars for
hanging 3 pcs.

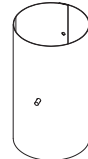

Chimney with
an air damper

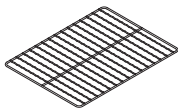

Smoker rack**

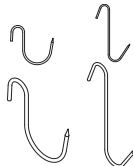

Smoking hooks**

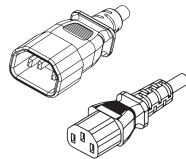

Power cord
C12 - C13



Wood chips 3x2L

SMOKE GENERATOR GD-01/GDS-01:

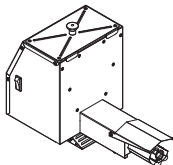

Smoke generator

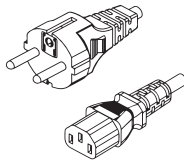

Power cord
EU* - C13

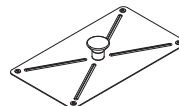

Cover for
the generator



Wood chips 2x2L

Illustrative drawings do not reflect the actual dimensions of the parts.

** the plug type depends on the distribution country*

*** type of product and quantity dependent on the set*

V. Construction and description of the operation

SMOKE GENERATOR

1. Lid
2. Wood chips hopper
3. Feeder and burner ON switch
4. Fuse
5. Power cord
6. Burner (heater)
7. Sawdust feeder
8. Latch
9. Burner cover
10. Air shutter

After switching on the smoke generator, the feeder (7) starts to rotate, at the same time the burner (6) begins to heat. The feeder uniformly transports chips from the storage tank (2) to the burner, where they start to smoulder. Smouldering chips are pushed through the entire length of the burner (6) where at the end they fall into a container filled with water.

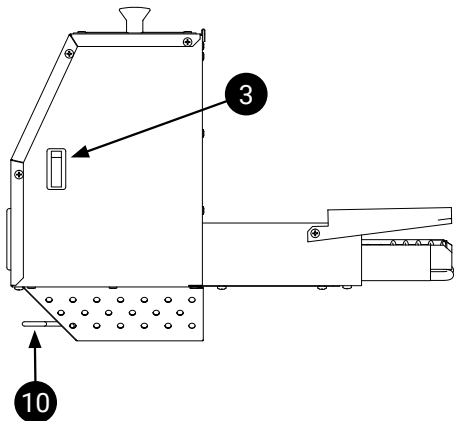
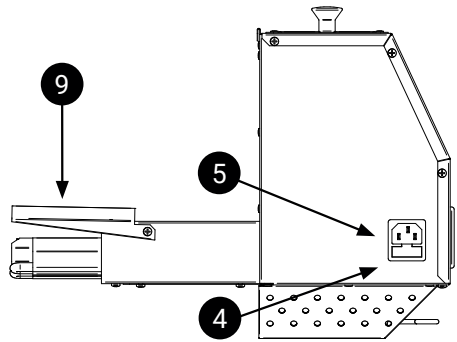
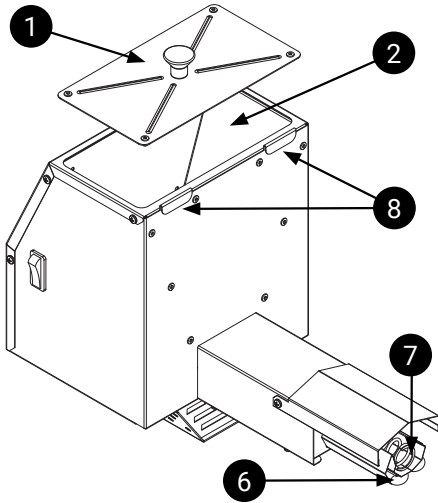

Using a smoker does not require any special skills, and the perfect smoking effect is achieved with a minimum of involvement.

SMOKER

1. Exhaust chimney with a baffle
2. Carrying handle
3. Electronic control panel
4. Drip tray
5. Door with magnetic closing
6. Temperature measurement probe
7. Burner
8. Condenser
9. Adjustable legs
10. Smoke generator

The smoke generator (10) causes slow and even smoke generation. A chimney with a baffle (1) at the top of the smoker regulates the smoke density in the chamber. A burner with a radiator (7) is installed in the main chamber.

Set the desired temperature in the chamber on the panel (3). The burner switches on depending on the needs and maintains the desired temperature. The condenser (8) is used to protect the smoked meats against dripping of smoke condensate. It should be cleaned after each use of the smoker. The drip tray (4) protects the smoking unit burner and the generator against the juice from the smoked meats.

In the smoking unit there are two bowls which are filled halfway with water and one is placed under the generator burner, the other under the drip tray opening (4). The first bowl is used to extinguish the falling chips, the second one is used to collect the juices from smoked meats. The ambient temperature and wind have a large impact on the operating conditions of the device. In unfavourable atmospheric conditions, the chamber heating time may increase. It is advisable to use an independent thermometer to measure the temperature inside the smoked product. The consumption of materials for the production of smoke is small - for about 1 hour about 250ml of smoking chips.

One generator charge of about 2l is enough for 6 to 8 hours of operation.

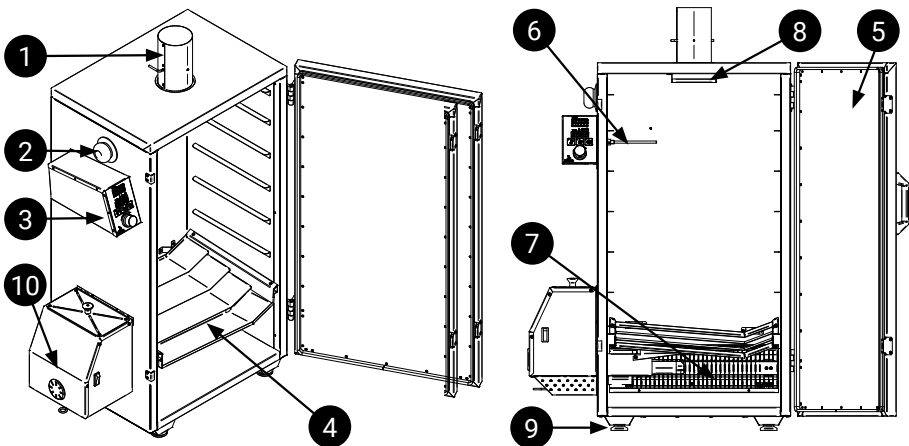

Reminder on the rules of use

When smoking fatty foods (and when there is a risk of fat melting), protect the drip tray so that fat does not drip onto it - it is best to use an additional metal bowl where fat may accumulate.

The fat pan should be placed at least on the second shelf, counting from the bottom

VI. Digital Control Panel Operation

1. Time controller display
2. Function keys
3. Temperature controller display
4. Information lamps for display (1)
5. Knob for temperature setting
6. Dryer power socket
7. Smoke generator power socket
8. Main switch
9. Fuse
10. Electrical connector - connection to the chamber
11. Power socket - connection to the power supply

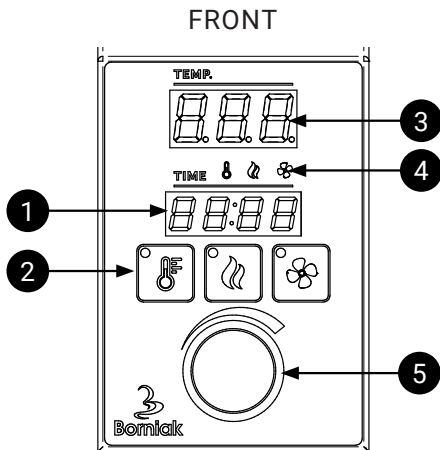

BACK

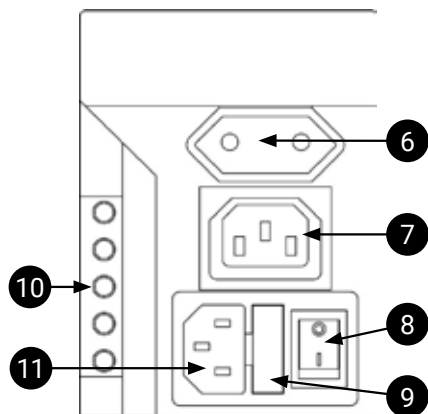



Connection:

Before connecting the power cables, connect the panel to the smoker in accordance with the instructions from chapter VII Assembly and installation. The socket (11) is used for connecting the panel with the smoking chamber. Connect the dryer to the dryer's power socket (6) (optional accessories not included with the device). Connect the smoke generator to the generator power socket (7). After connecting the socket (6) [optional] and socket (7), connect the power cord to the socket (11).



Description of the operation:

After connecting the cables, start the device with the button (8).



Turn on the heat:

- Start the control panel with the button (8),
- Press (2)  on the control panel. The lamp  of heating function button will light up. The heating function is switched on.

Turn on the smoke generator:

- Before switching on, make sure that the generator is positioned according to the instructions from chapter VII Assembly and installation.
- Turn on the power button on the smoke generator first
- Start the control panel with the button (8),
- Press (2)  on the control panel. The lamp  of smoke function button will light up. The heating function is switched on.

Turn on the dryer (optional):

- Before switching on, make sure that the dryer is connected to the smoker in accordance with the instructions. (Remember: the dryer cannot be connected with a smokegenerator!)
- Start the control panel with the button (8), Press (2)  on the control panel. The lamp  of drying function button will light up. The heating function is switched on.

IMPORTANT: When the dryer is turned on, the smoke generator is turned off.

Change target temperature:

- Press the knob
- Set the desired temperature
- Press the knob again

After setting the temperature correctly, you will hear the sound.

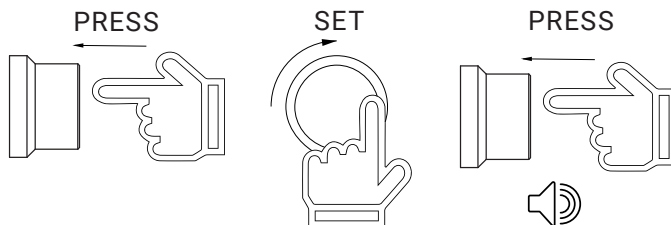

Description of the function keys:



Pressing - turns the heater on / off

Press for approx. 2 seconds - time setting

The lamp is on - heating is on

The lamp flashes - the heater is running with a time countdown



Pressing - turns on/off the smoke generator

Press for approx. 2 seconds - time setting

The lamp is on - the smoke generator is on

The lamp flashes - the smoke generator is running with a countdown



Pressing - turns dryer on/off

press for approx. 2 seconds - time setting

Lamp is on - dryer is on

The lamp flashes - the dryer is turned on with the countdown of time

Time view for a specific function:

The illuminated symbol (4) shows the function for which the time is shown on the display (1). Turn the knob (5) to change the lit icon (4) and the operating time shown on the display (1).



Setting the time:

• Keep the button (2) pressed for 2s,



or



or



• The first two fields for setting the hours will start flashing on the display (1).





• Use the rotary knob (5) to set the appropriate value and confirm by pressing the knob.

• The next two fields to set the minutes will start flashing on the display.



• Use the rotary knob (5) to set the appropriate value and confirm by pressing the knob.

After switching on  or  or  the time for a specific function is counted down, the lamp starts flashing. When the countdown ends, the device turns off.

Turning off time:

Follow the instruction to set the time. Set the value to 00:00 (--:--)

Note:

The time can be set for each of the three functions. Heating, smoke generator or dryer. If the time is not set, the display (1) will show how much time has passed since the function was enabled.

Electronic temperature controller operates on the principle of reaching the desired temperature by cycling on and off the heating element. This provides a stable temperature.

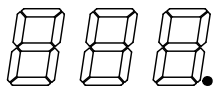

The lower right dot indicates the operation of the heater.
Light's On - the heater works constantly
Blinking - the heater is working cyclically
Light's Off - the heater is not working



Error: damaged or wrong type of temperature probe. Turn off the device. Disconnect the power cord from the power supply. The error should be reported to the seller or service.



Error: temperature probe not detected. Turn off the device. Disconnect the power cord from the power supply. Check the connection between the cabinet and the panel. If the error persists, report it to the seller or service.



Continuous acoustic signal means that the limit temperature is exceeded. Be careful it may be caused by the flame!
Remember: When preparing fatty smoked meats, place an additional bowl for the dripping fat.

COMMENTS

- The temperature in the chamber cannot be lower than the atmospheric temperature.
- If we do not use the cold smoking adapter, the temperature in the chamber may rise to 70 °C depending on the model of the smoker and weather conditions. This is because the smoke generator produces heat while burning the wood chips, which raises the temperature inside the device.
- When the set temperature is reached for the first time, it is possible to exceed it by 10–15%. It is not a malfunction of the controller.
- At high temperatures, above 100 °C, it may take longer to reach the set temperature due to the slowing down of the heating process.
- Fat can melt at high temperatures. Use an extra bowl (do not place this on top of the separator bowl) to prevent excess fat from dripping onto the separator bowl.

VII. Assembly and installation

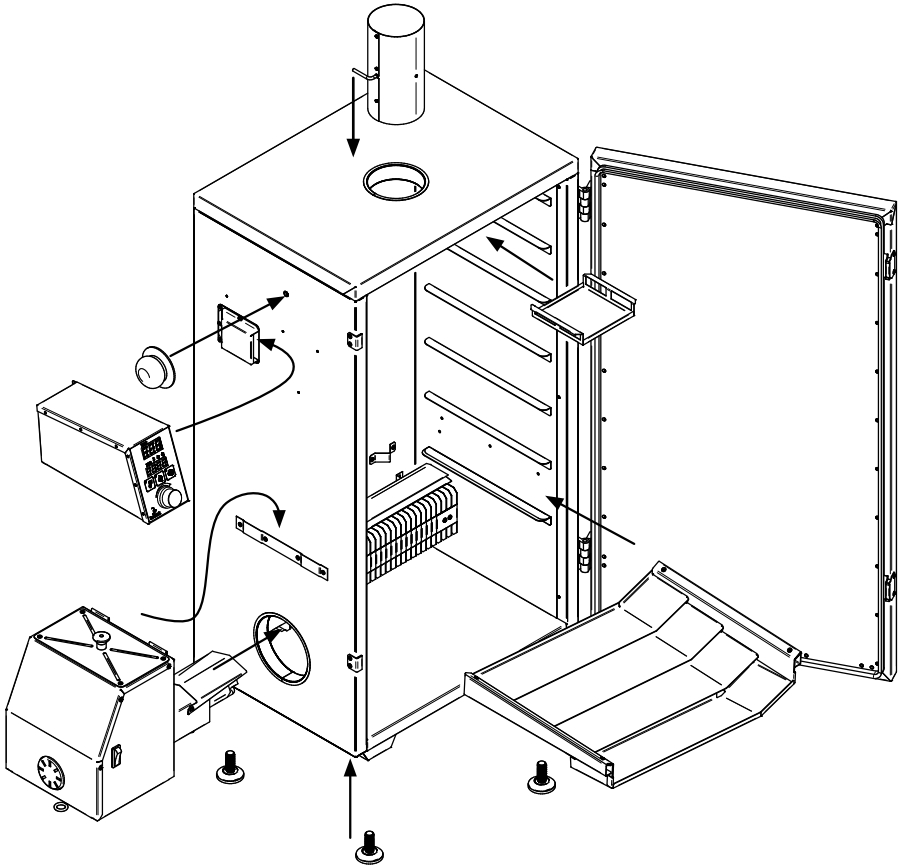

1. After taking out of the carton, remove unnecessary packaging and elements protecting the product and read the instructions.

2. Screw two handles to carry the device.

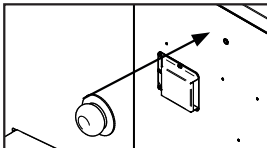

3. Screw the handle to open the door.

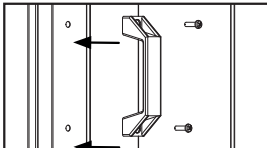

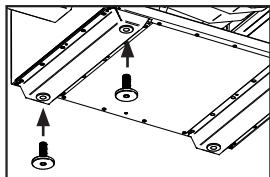

4. Place the device in a suitable place, slightly tilting the smoking unit, insert the legs into the slots on the bottom and adjust them so that the device reaches the level.

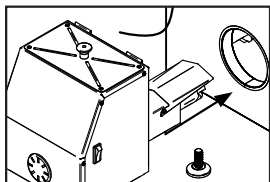

5. Insert the protruding heating element of the smoke generator into the side hole on the left side of the smoker. Tilt the generator slightly to put it on the latches.

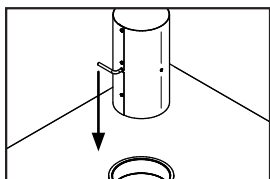

6. Insert the chimney into the hole at the top of the smoker. Pay attention to the correct position of the throttle valve.

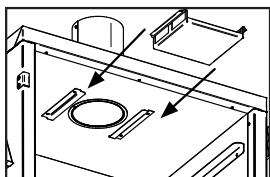

7. Insert the condenser under the chimney.

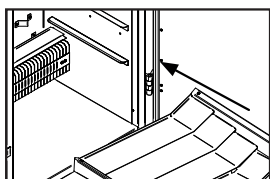

8. Insert the drip tray onto the bottom rack.

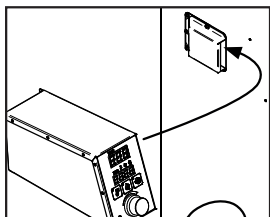

9. Mount the electronic control panel - see the description p. 14.

PLEASE NOTE THE FOLLOWING SAFETY INFORMATION

When smoking very fatty foods on the grates, please use an additional drip tray or metal bowl over the separating plate to catch melting fat to prevent a fat fire. Position the tray in the second slot from the bottom. With the size of the bowl, make sure there is sufficient air circulation on all sides. Alternatively, smoke the food directly in a bowl. Make sure the two bowls under the divider are emptied when needed. There should always be some water in the bowl for the ashes.

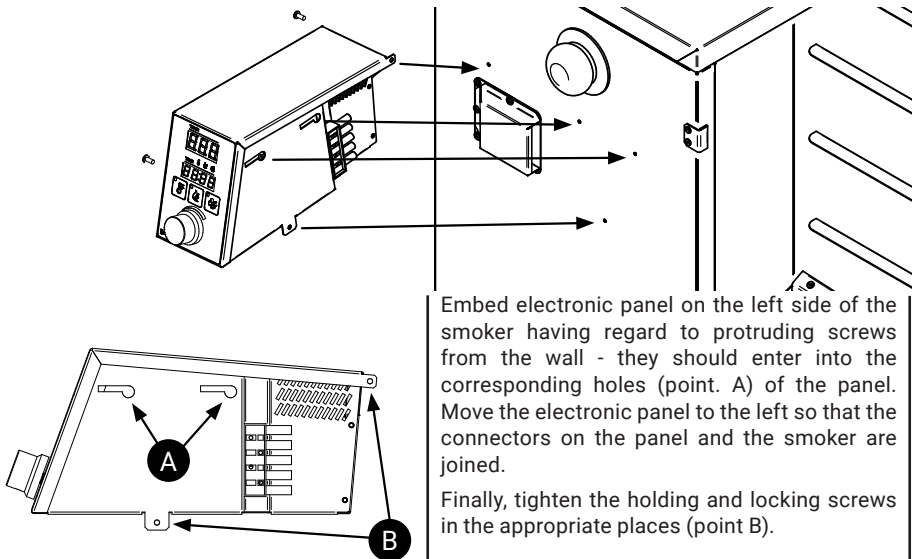

Embed electronic panel on the left side of the smoker having regard to protruding screws from the wall - they should enter into the corresponding holes (point. A) of the panel. Move the electronic panel to the left so that the connectors on the panel and the smoker are joined.

Finally, tighten the holding and locking screws in the appropriate places (point B).

VIII. First start

Fill the bowls halfway with water and place them under the generator burner - under the drip tray openings. Fill the generator hopper with the supplied chips and slightly open the air damper at the top of the smoker. The bowls should be cleaned and filled with fresh water every 2 - 4 hours.

Connect the generator and the smoker to 230V mains with protective grounding. Switch to start the smoke generator and the smoking unit, on the electronic panel set the temperature to approx. 80°C (see: Operation of the electronic control panel)

Heat the smoker for about 2 hours. This will reduce technological odours and ensure initial flavouring of the device. After heating, you can start the proper smoking.

NOTE: Fill the storage tank of the smoke generator only with wood chips indicated by the device manufacturer.

Warm smoking (30°C - 60°C) - With only the smoke generator on, we can conduct warm smoking. In unfavorable atmospheric conditions, we can turn on the smoking unit by setting

the right temperature on the temperature controller.

Hot smoking (60°C - 90°C) - Turn on the generator and the smoking unit, and set the electronic panel to the desired temperature.

IX. Maintenance

After finishing smoking, disconnect the generator and the smoking unit from the power supply. It is necessary to clean the smoker: it is best to use water with washing-up liquid. The interior of the smoker should have residue after smoking, it should not be scrubbed or washed with caustic agents. If there is fat or other deposits on the housing, wipe them gently with a damp cloth.

The shutter and the bowl in which fat and ash are collected, must be kept clean because excess fat may ignite.

NOTE: When smoking excess fat falling very fat products, control on the shutter, it must be removed unconditionally.

NOTE: During the operation of the device, carbon deposit forms on the part of the sawdust feeder. It should be removed after 8 hours of the generator operation, using a scraper, pliers or other blunt tool. Failure to remove carbon deposits can result in poor operation of the device and, in the worst case, its damage.

When cleaning, make sure that you do not use any cleaning agents containing chlorine, bleaching agents, or strong acidic or alkaline agents. Before using a cleaning agent, we recommend that you always check the compatibility on the surface to be cleaned in an invisible place.

X. Questions and answers

During operation of the device, the temperature indicated on the external thermometer is higher than set on the thermostat.

When working in an empty chamber, the air stream passes through the centre where the tip of the thermometer is located. Temperatures should be the same when working with the charge, which causes mixing of warm air and its even distribution in the whole chamber. Temperature differences may also be affected by atmospheric conditions.

The thermostat has turned off, the temperature in the chamber is still increasing.

The temperature in the chamber increases after turning off the thermostat due to inertia. So the heating element releases heat accumulated in itself after turning off for a certain time. For stable operation of the device, it is recommended to place a bowl with water under the generator burner. This improves the temperature stability inside the chamber.

The chips burn on the smoke generator burner.

Do not connect the smoker chimney outlet to chimneys, ventilation shafts or other extensions of the smoke outlet due to the possibility of producing draft in the smoker, which can cause wood chips to ignite. The only way that is acceptable for extending the smoke outlet, is to apply a hood over the smoker so that smoke can be extracted from the smoker at its own speed.

Igniting wood chips may cause accumulated carbon deposit on the feeder and unfavourable weather conditions (e.g. wind gusts). Both these factors should be eliminated by removing the carbon deposit and protecting the smoker from the gusts of wind or covering the air inlet under the smoke generator.

Smoke is led outside at the bottom of the smoker or through the smoke generator.

The chimney is too closed, it should be tilted enough to let the smoke come out only through it.

There is no smoke escaping from the chimney.

No smoke is a sign that a flame has appeared on the smoke generator. Stop the smoke generator immediately and put out the flame. The reason for this phenomenon may be the connection of the smoker to chimney flues or gusts of wind.

X. Warranty card

This warranty is effective for 24 months from the date of purchase. The warranty as described herein shall only apply in the territory of the Republic of Poland.

TERMS OF WARRANTY:

1. ZUT BORNIAK guarantees the user efficient operation of the appliance provided its proper installation, maintenance and operation, in accordance with the guidelines of this MANUAL.
2. ZUT BORNIAK takes responsibility for manufacturer's defects (i.e. in material or workmanship) of the appliance for 24 months from the date of its selling.
3. The defects of products which shall arise during the warranty period will be removed in the time not longer than 30 days from the day of returning it to the manufacturer.
4. The warranty flows only to the Buyer, i.e. a natural person, who purchases a moveable item for a purpose different than conducting business activities or any professional activities. (Journal of Laws of 2002, No 141, item 1176).
5. The defective appliance must be returned with its standard accessories, in its original packaging.
6. When sending in your defective appliance for service, a valid Warranty Card, without any traces of changes or interference, must be included.
7. Damage resulting from events such as: lightning strike, power surge in power lines, mechanical impacts, fires, flooding or other uncontrollable events beyond the Seller's control, are not covered by this warranty.
8. The User shall deliver the defective product for service repair purposes at their own expense. After the repair, the appliance shall be returned to its owner at the Manufacturer's expense.
9. It is recommended to contact the Manufacturer before sending in the defective appliance.
10. While sending the appliance to the Manufacturer, the User must include their contact details, the return address, as well as a short description of the defect.
11. Liability of the Manufacturer is limited to the amount equal to the price of the defective product.
12. Damages and missing goods in the case of orders delivered by Poczta Polska or courier companies shall be dealt with only based on the report drawn up by the courier while delivering the parcel.

Date of sale:

Device serial number:

Proof of purchase No:

Seller's signature:

Stamp: